

SKM 500

Instructions for use

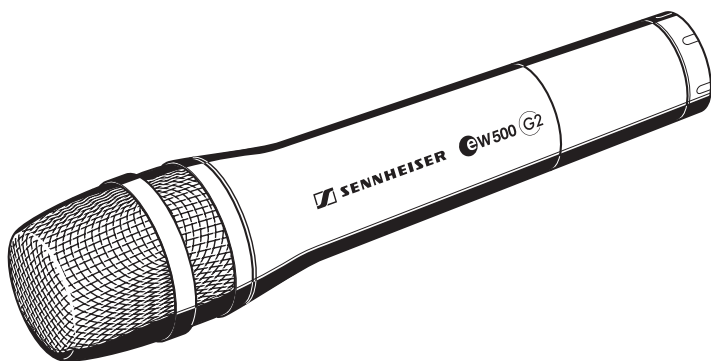

Thank you for choosing Sennheiser!

We have designed this product to give you reliable operation over many years. Over half a century of accumulated expertise in the design and manufacture of high-quality electro-acoustic equipment have made Sennheiser a world-leading company in this field.

Please take a few moments to read these instructions carefully, as we want you to enjoy your new Sennheiser product quickly and to the fullest.

Contents

The SKM 500 G2 radiomicrophone family	36
The channel bank system	36
Safety instructions	37
Delivery includes	37
Areas of application	38
The operating controls	39
Indications and displays	40
Preparing the radiomicrophone for use	42
Inserting/replacing the batteries	42
Changing the microphone head	43
Using the radiomicrophone	45
Switching the radiomicrophone on/off	45
Muting the radiomicrophone	46
Activating/deactivating the lock mode	46
The operating menu	47
The buttons	47
Overview of menus	47
Working with the operating menu	48
Operating menu of the radiomicrophone	50
Adjustment tips for the operating menu	52
Switching between channel banks	52
Switching between the channels in a channel bank ..	52
Selecting the frequencies to be stored in the channel bank "U"	52
Adjusting the sensitivity	53
Selecting the standard display	54
Entering a name	54
Loading the factory-preset default settings	54
Activating/deactivating the pilot tone transmission	55
Activating/deactivating the lock mode	55
Exiting the operating menu	55
Troubleshooting	56
Error checklist	56
Recommendations and tips	57
Care and maintenance	58
Specifications	59
Polar diagrams and frequency response curves of microphone heads	60
Accessories	61

The SKM 500 G2 radiomicrophone family

The SKM 500 G2 radiomicrophone family is part of the evolution wireless series ew 500 G2. With this series, Sennheiser offers high-quality state-of-the-art RF transmission systems with a high level of operational reliability and ease of use. Transmitters and receivers permit wireless transmission with studio-quality sound. The excellent transmission reliability of the ew 500 G2 series is based on the use of

- further optimized PLL synthesizer and microprocessor technology,
- the HDX noise reduction system,
- and the pilot tone squelch control.

The channel bank system

The radiomicrophone is available in five UHF frequency ranges with 1440 transmission frequencies per frequency range. Please note: Frequency usage is different for each country. Your Sennheiser agent will have all the necessary details on the available legal frequencies for your area.

Range A: 518 to 554 MHz

Range B: 626 to 662 MHz

Range C: 740 to 776 MHz

Range D: 786 to 822 MHz

Range E: 830 to 866 MHz

The radiomicrophone has nine channel banks with up to 20 switchable channels each.

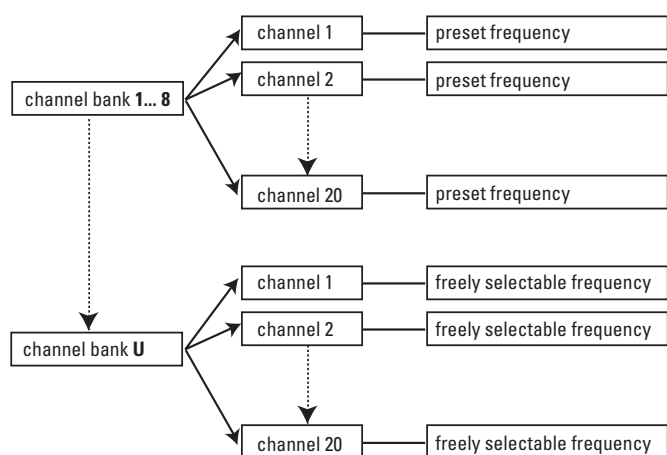

Each of the channels in the channel banks "1" to "8" has been factory-preset to a transmission frequency (see enclosed frequency table). These transmission frequencies cannot be changed but have been preset so that e.g. country-specific regulations on frequency usage are taken into account.

The channel bank "U" (user bank) allows you to store your

selection out of 1440 transmission frequencies that are freely selectable within the preset frequency range.

Safety instructions

Never open an electronic unit! If units are opened by customers in breach of this instruction, the warranty becomes null and void.

Use the unit in dry rooms only.

Use a damp cloth for cleaning the unit. Do not use any cleansing agents or solvents.

Delivery includes

The packaging contains the following items:



- 1 SKM 500 G2 radiomicrophone
- 2 batteries
- 1 microphone clamp
- Instructions for use
- 1 pouch

Areas of application

The SKM 500 G2 radiomicrophone family can be combined with receivers of the ew 500 G2 series (EM 500 G2 rack-mount receiver or EK 500 G2 bodypack receiver). The receivers are available in the same five UHF frequency ranges and are equipped with the same channel bank system with factory-preset frequencies. An advantage of the factory-preset frequencies is that

- a transmission system is ready for immediate use after switch-on,
- several transmission systems can be operated simultaneously on the preset frequencies without causing intermodulation interference.

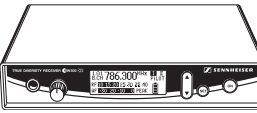
Together with a matching receiver, the radiomicrophone is suitable for the following areas of application:

Transmitter	Receiver (to be ordered separately)	Area of application
SKM 535 G2 ¹⁾ SKM 545 G2 ¹⁾ SKM 565 G2 ¹⁾	EM 500 G2 	<ul style="list-style-type: none"> • Presentation • Vocals
	EK 500 G2 	<ul style="list-style-type: none"> • Speech • Vocals • Presentation • Camera-mounted applications

The name¹⁾ of the radiomicrophone is a combination of the name of the transmitter and the name of the microphone head:

Transmitter+Microphone head = Name of radiomicrophone
SKM 500 + MD 835 = SKM 535

Each microphone head comes with a color-coded identification ring to distinguish different microphone heads from each other.

Microphone head	Color of identification ring	Transducer principle	Pick-up pattern	Area of application
MD 835	green	dynamic	cardioid	Speech, vocals
MD 845	blue	dynamic	super-cardioid	Vocals (high feedback rejection)
ME 865	red	condenser	super-cardioid	Vocals (high feedback rejection)
MMD 935 ²⁾ (optional)	silver	dynamic	cardioid	Vocals (in venues with high ambient noise levels)

²⁾ only available as optional microphone head

The operating controls

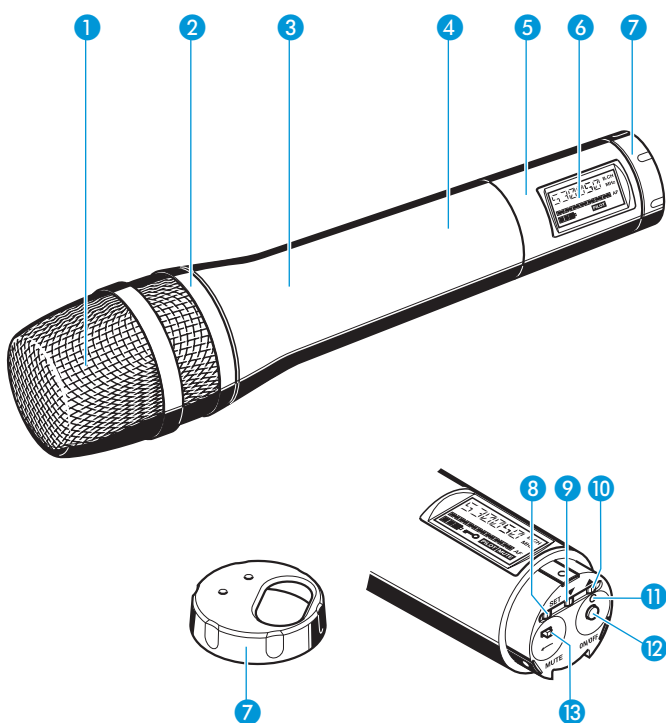

- 1 Sound inlet basket
- 2 Color-coded identification ring for microphone heads
green: MD 835 microphone head
blue: MD 845 microphone head
red: ME 865 microphone head
- 3 Body of radiomicrophone
- 4 Battery compartment (not visible from outside)
- 5 Display section
- 6 LC display
- 7 Turnable protective cap for operating controls (shown removed)

The following operating controls become accessible in turn by turning the protective cap:

- 8 SET button
- 9 ▼ button (DOWN)
- 10 ▲ button (UP)
- 11 Red LED for operation and battery status indication (ON/LOW BAT)
- 12 ON/OFF button
(serves as the ESC (cancel) key in the operating menu)
- 13 MUTE switch

Indications and displays

LC display panel

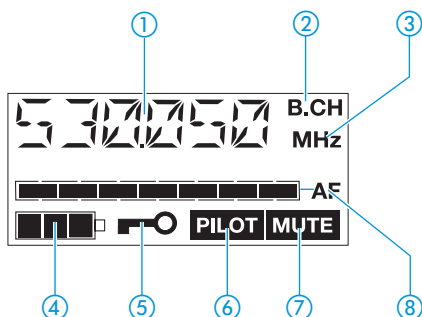

- ① Alphanumeric display
- ② "B.CH" – appears when the channel bank and the channel number are displayed
- ③ "MHz" – appears when the frequency is displayed
- ④ 4-step battery status display
- ⑤ Lock mode icon (lock mode is activated)
- ⑥ "PILOT" display (pilot tone transmission is activated)
- ⑦ "MUTE" display (audio input is muted)
- ⑧ 7-step level display for audio signal "AF"

Operation and battery status indication

The red LED (LOW BAT/ON) ⑪ provides information on the current operating state of the radiomicrophone:

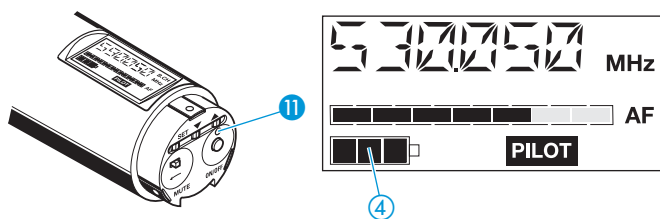

Red LED lit up: The radiomicrophone is switched on and the capacity of the batteries/BA 2015 accupack is sufficient.

Red LED flashing: The batteries are/the BA 2015 accupack is going flat (LOW BAT)!

In addition, the 4-step battery status display ④ on the display panel provides information on the remaining battery/BA 2015 accupack capacity:

3 segments: capacity approx. 100 %

2 segments: capacity approx. 70 %

1 segment: capacity approx. 30 %

Battery icon flashing: LOW BAT

“MUTE” display

The “MUTE” display ⑦ appears on the display panel when the radiomicrophone is muted (see “Muting the radiomicrophone” on page 46).

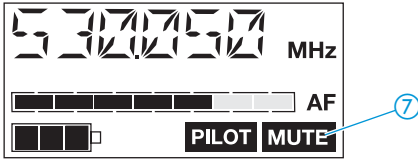

Modulation display

The level display for audio signal “AF” ⑧ shows the modulation of the radiomicrophone.

When the audio input level is excessively high, the level display for audio signal “AF” ⑧ shows full deflection for the duration of the overmodulation.

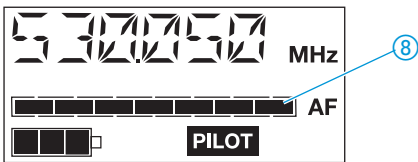

“PILOT” display

The “PILOT” display ⑥ appears on the display panel when the pilot tone transmission is activated (see “Activating/deactivating the pilot tone transmission” on page 55).

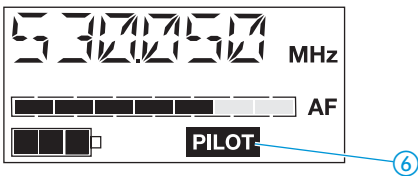

Display backlighting

After pressing a button, the display remains backlit for approx. 15 seconds.

Preparing the radiomicrophone for use

Inserting/replacing the batteries

For powering the radiomicrophone, you can either use two 1.5 V AA size batteries or the rechargeable Sennheiser BA 2015 accupack.

- ▶ Unscrew the display section 5 from the radiomicrophone's body 3 by turning it counter-clockwise.

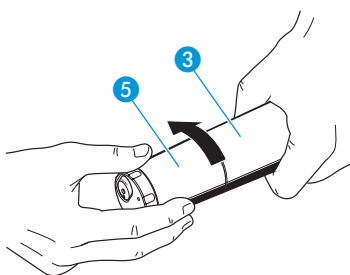

- ▶ Slide back the display section 5 as far as it will go.

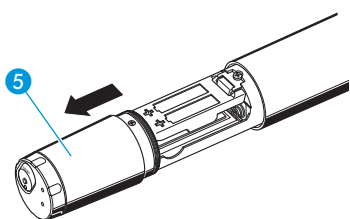

- ▶ Open the battery compartment cover 14.

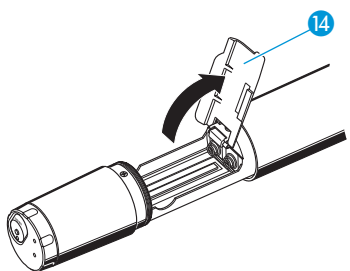

- ▶ Insert the two batteries or the BA 2015 accupack as shown. Please observe correct polarity when inserting the batteries/accupack.

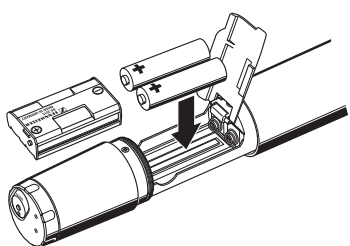

- ▶ Close the battery compartment cover 14.

- ▶ Push the battery compartment into the radiomicrophone's body.
- ▶ Screw the display section tight.

Note:

For accupack operation of the radiomicrophone, only use the BA 2015 accupack in order to ensure optimum operational reliability. For charging the accupack, only use the L 2015 charger. Both the accupack and the charger are available as accessories.

The accupack is fitted with an integrated sensor which is – via a third contact – monitored by the electronics of the radiomicrophone and the charger. The sensor is necessary for the following control purposes:

- The taking into account of the different voltage characteristics of primary cells (batteries) and accupacks. The battery status indications on the displays, the transmission of transmitter battery status information to the rack-mount receivers and the switch-off thresholds at the end of the operating time are corrected correspondingly. Due to the missing sensor, individual rechargeable battery cells will not be identified as accupacks.
- The monitoring of the accupack temperature during charging in the L 2015 charger.

Changing the microphone head

- ▶ First remove the batteries/accupack as described above and leave the radiomicrophone open.
- ▶ Unscrew the sound inlet basket.
- ▶ Loosen the screw and put it to one side.

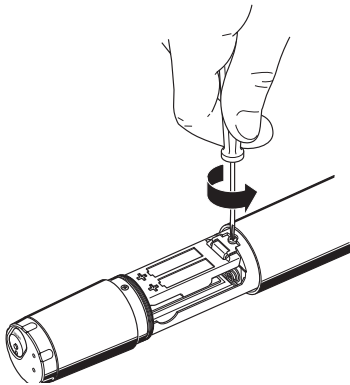

- ▶ Gently ease the capsule out of the contacts and then pull it out of the housing as shown. Do not touch the contacts and the diaphragm!

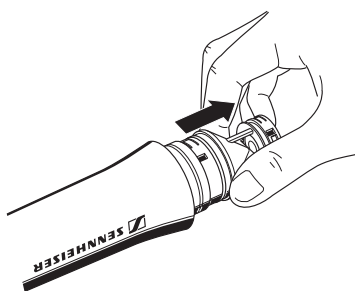

- ▶ Insert the new capsule.
- ▶ Secure the capsule by tightening the screw.

Note:

The screw mechanically secures the microphone capsule. If the screw is missing, malfunctions may occur during tough use.

- ▶ Put on the sound inlet basket and identification ring supplied with the new microphone head (NB: do NOT use the old basket, as the different heads use slightly differing internal foam) and screw it tight.
- ▶ Insert the batteries/accupack.
- ▶ Close the radiomicrophone and put it into operation.

Note:

Microphone capsule, sound inlet basket and foam insert form an acoustic unit and must therefore always be exchanged all together. Each microphone head comes with a color-coded identification ring to distinguish different microphone heads from each other (green = MD 835, blue = MD 845, red = ME 865).

Using the radiomicrophone

Switching the radiomicrophone on/off

The radiomicrophone can only be switched off when the standard display is shown on the display panel. When in the operating menu, briefly pressing the **ON/OFF** button will cancel your entry (ESC function) and return you to the standard display with the last stored settings.

Note:

Remove the batteries or the accupack when the radiomicrophone will not be used for extended periods of time.

- ▶ Turn the protective cap **7** at the bottom of the radiomicrophone so that the **ON/OFF** button **12** becomes accessible.

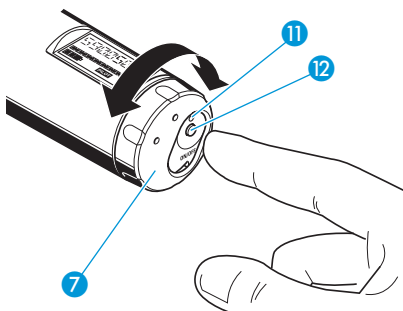

- ▶ Press the **ON/OFF** button to switch the radiomicrophone on. The red LED **11** lights up.
- ▶ To switch the radiomicrophone off, press the **ON/OFF** button **12** until "OFF" appears on the display. The red LED **11** goes off.

Muting the radiomicrophone

The radiomicrophone has a **MUTE** switch that noiselessly mutes the audio signal without switching the radiomicrophone off.

- ▶ Turn the protective cap **7** at the bottom of the radiomicrophone so that the **MUTE** switch **13** becomes accessible.

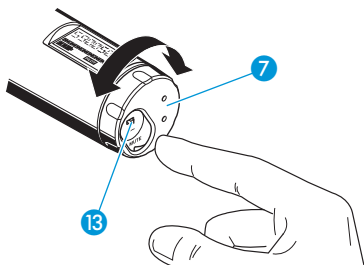

- ▶ Set the **MUTE** switch to the position 'MUTE'. The "MUTE" display appears on the radiomicrophone's display panel. Provided that the pilot tone function is activated on both the transmitter and the receiver, the "MUTE" display also appears on the receiver display panel.
- ▶ Set the **MUTE** **13** switch back to the original position to retransmit the audio signal.

Activating/deactivating the lock mode

The radiomicrophone has a lock mode that can be activated or deactivated via the operating menu (see "Activating/deactivating the lock mode" on page 55). The lock mode prevents that the radiomicrophone is accidentally programmed or switched off during operation.

The operating menu

A special feature of the Sennheiser ew 500 G2 series is the similar, intuitive operation of transmitters and receivers. As a result, adjustments to the settings can be made quickly and “without looking” – even in stressful situations, for example on stage or during a live show or presentation.

The buttons

Buttons	Mode	To...
ON/OFF	Standard display	switch the radiomicrophone on and off
	Operating menu	cancel the entry and return to the standard display
	Setting mode	cancel the entry and return to the standard display
SET	Standard display	get into the operating menu
	Operating menu	get into the setting mode of the selected menu
	Setting mode	store the settings and return to the top menu level
▲/▼	Standard display	without function
	Operating menu	change to the previous menu (▲) or change to the next menu (▼)
	Setting mode	adjust the setting of the selected menu: option (▲/▼)

Overview of menus

Display	Function of the menu
BANK	Switching between channel banks
CHAN	Switching between the channels in a channel bank
TUNE	Setting a transmission frequency for the channel bank “U” (user bank)
SENSIT	Adjusting the sensitivity (AF)
DISPLY	Selecting the standard display
NAME	Entering a name
RESET	Loading the factory-preset default settings
PILOT	Activating/deactivating the pilot tone transmission
LOCK	Activating/deactivating the lock mode
EXIT	Exiting the operating menu and returning to the standard display

Working with the operating menu

By way of example of the "TUNE" menu, this section describes how to use the operating menu.

After switching the radiomicrophone on, the standard display is shown on the display panel.

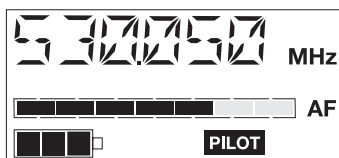

Getting into the operating menu

- ▶ Press the **SET** button to get from the standard display into the operating menu. The last selected menu flashes on the display.

Selecting a menu

- ▶ Press the **▲/▼** buttons to select a menu.



- ▶ Press the **SET** button to get into the setting mode of the selected menu. The current setting that can be adjusted flashes on the display.



Adjusting a setting

- ▶ Press the **▲/▼** buttons to adjust the setting.



By briefly pressing the **▲/▼** buttons, the display jumps either forwards or backwards to the next setting. In the "CHAN", "TUNE" and "NAME" menu, the **▲/▼** buttons feature a "fast search" function. If you hold down a button, the display cycles continuously, allowing you to get fast and easily to your desired setting.

Storing a setting

- ▶ Press the **SET** button to store the setting. "STORED" appears on the display, indicating that the setting has been stored. The display then returns to the top menu level.



With most menus, new settings become effective immediately without having to be stored. An exception are the "BANK", "CHAN", "TUNE" and "RESET" menus. With these menus, new settings only become effective after they have been stored ("STORED" appears on the display, indicating that the setting has been stored).

Exiting the operating menu

- ▶ Select the "EXIT" menu to exit the operating menu and to return to the standard display.



When in the operating menu, briefly pressing the **ON/OFF** button will cancel your entry (ESC function) and return you to the standard display with the last stored settings.

Operating menu of the radiomicrophone

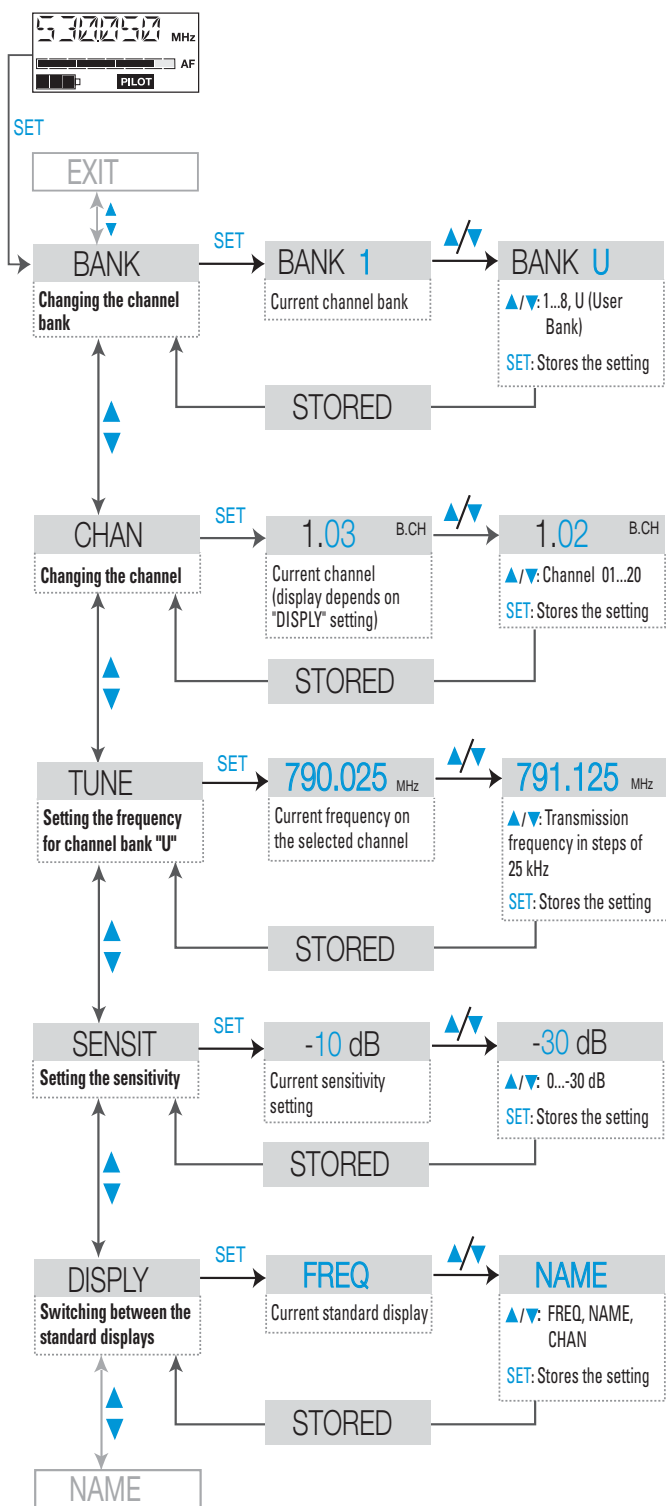

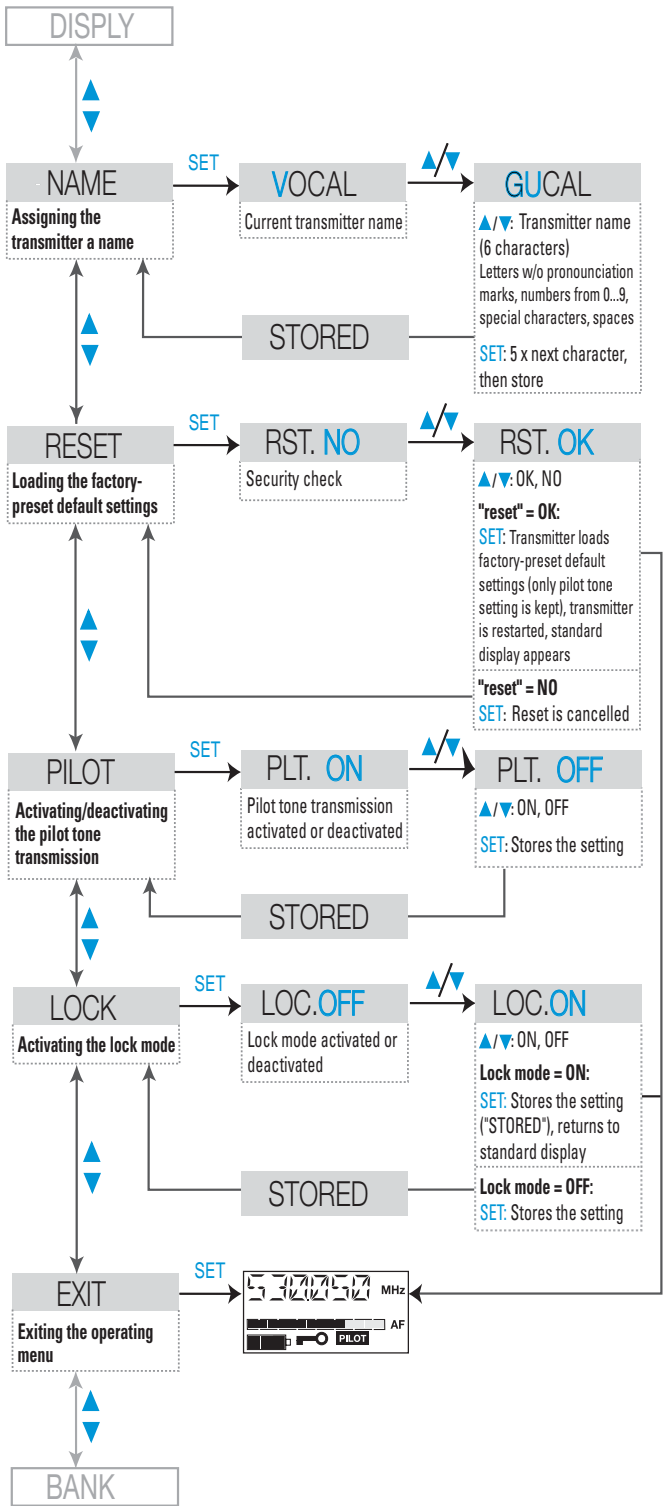

Adjustment tips for the operating menu

Switching between channel banks – **BANK**

Via the “**BANK**” menu, you can switch between the radiomicrophone’s nine channel banks. Each of the channel banks “1” to “8” has up to 20 switchable channels that are factory-preset to a transmission frequency (see “The channel bank system” on page 36). The channel bank “U” (user bank) has up to 20 switchable channels to store your selection out of 1440 transmission frequencies that are freely selectable within the preset frequency range.

When switching from one channel bank to another, the channel with the lowest channel number is automatically displayed.

Switching between the channels in a channel bank – **CHAN**

Via the “**CHAN**” menu, you can switch between the different channels in a channel bank. When switching between the channels, please observe the following:

Always set the transmitter and the receiver of a transmission link to the same channel.

Multi-channel operation

Combined with ew 500 G2 receivers, the radiomicrophone can form transmission links that can be used in multi-channel systems. For multi-channel operation, only use the free channels in a channel bank.

Before putting the transmission links into operation, we recommend performing an auto scan (see operating manual of the receiver).

Selecting the frequencies to be stored in the channel bank “U” – **TUNE**

Via the “**TUNE**” menu, you can select the frequencies to be stored in the channel bank “U” (user bank).

When you have selected one of the channel banks “1” to “8” and then select the “**TUNE**” menu, the radiomicrophone automatically switches to channel 01 of the channel bank “U”.

In this case, "U.01" briefly appears on the display.



- ▶ Use the ▲/▼ buttons to select the desired transmission frequency. Transmission frequencies are tunable in 25-kHz steps within a switching bandwidth of 36 MHz max. For intermodulation-free frequencies, please refer to the enclosed frequency table.

Adjusting the sensitivity – SENSIT

Via the "SENSIT" menu, you can adjust the radiomicrophone's input sensitivity.

The input sensitivity is adjusted too high when close talking distances, speakers with loud voices or loud music passages cause overmodulation in the transmission link. When the audio input level is excessively high (AF peak), the level display for audio signal "AF" ⑧ shows full deflection.

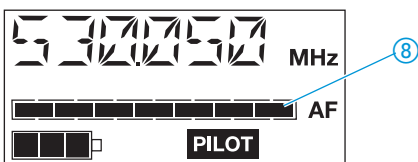

If, on the other hand, the sensitivity is adjusted too low, the transmission link will be undermodulated, which would result in a signal with high background noise.

The sensitivity is correctly adjusted when the level display for audio signal "AF" ⑧ shows full deflection only during the loudest passages.

Note:

For monitoring the adjusted sensitivity, the transmitter's level display for audio signal "AF" always indicates the audio level – even if the transmitter is muted.

The following figures are a guide to the best settings:

- Loud music/vocals: –30 to –20 dB
- Presentations: –20 to –10 dB
- Interviews: –10 to 0 dB

Selecting the standard display – **DISLPY**

Via the “**DISPLY**” menu, you can select the standard display:

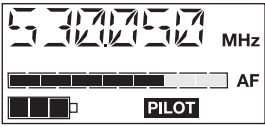
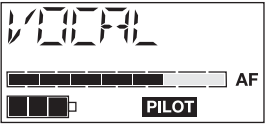
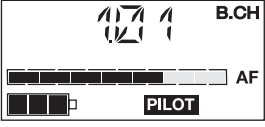
Selectable standard display	Contents of standard display
“ FREQ ”	
“ NAME ”	
“ CHAN ”	

Entering a name – **NAME**

Via the “**NAME**” menu, you can enter a freely selectable name for the radiomicrophone. You can, for example, enter the name of the performer for whom the adjustments have been made.

The name can be displayed on the standard display and can consist of up to six characters such as:

- letters (without pronunciation marks),
- numbers from 0 to 9,
- special characters e.g. () - . _ and spaces.

To enter a name, proceed as follows:

- ▶ Press the **SET** button to get into the setting mode of the “**NAME**” menu. The first segment starts flashing on the display.
- ▶ With the **▲/▼** buttons you can now select a character. By briefly pressing a button, the display jumps either forwards or backwards to the next character. If you hold down a button, the display starts cycling continuously.
- ▶ Press the **SET** button to change to the next segment and select the next character.
- ▶ Have you entered the name completely? Press the **SET** button to store your setting and to return to the top menu level.

Loading the factory-preset default settings – **RESET**

Via the “**RESET**” menu, you can load the factory-preset default settings. Only the selected setting for the pilot tone remains unchanged. After the reset, the radiomicrophone is restarted and the standard display is shown on the display panel.

Activating/deactivating the pilot tone transmission – PILOT

Via the “PILOT” menu, you can activate or deactivate the pilot tone transmission.

The pilot tone supports the receiver’s squelch function (Squelch) and protects against interference due to RF signals from other units. The transmitter adds an inaudible signal, known as the pilot tone, to the transmitted signal. The receiver detects and evaluates the pilot tone, and is thus able to identify the signal of the matching transmitter and mute all others.

Transmitters of the ew 500 series (first generation) do not transmit a pilot tone and the receivers of the ew 500 series (first generation) cannot evaluate the pilot tone. Nevertheless, you can combine the radiomicrophone with a receiver of the first generation. However, when combining units, please observe the following:

- With the ew 500 G2 radiomicrophone and an ew 500 G2 receiver:
Activate the pilot tone function with both radiomicrophone and receiver.
- With the ew 500 G2 radiomicrophone and an ew 500 receiver or vice versa:
Deactivate the pilot tone function with the ew 500 G2 radiomicrophone or receiver.

Activating/deactivating the lock mode – LOCK

Via the “LOCK” menu, you can activate or deactivate the lock mode.

The lock mode prevents that the radiomicrophone is accidentally programmed or switched off during operation. The lock mode icon ⑦ on the display indicates that the lock mode is activated.

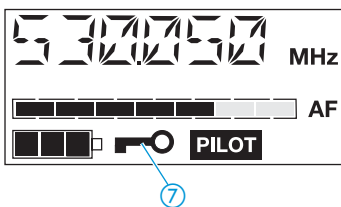

To deactivate the lock mode, first press the SET button and then press the ▲/▼ buttons to select “LOC.OFF”. If you confirm your selection by pressing the SET button, the buttons can be operated as usual.

Exiting the operating menu – EXIT

Via the “EXIT” menu, you can exit the operating menu and return to the standard display.

Troubleshooting

Error checklist

Problem	Possible cause	Possible solution
No operation indication	Batteries are flat or accupack is flat	Replace the batteries or recharge the accupack
No RF signal	Transmitter and receiver are not on the same channel	Set transmitter and receiver to the same channel
	Transmitter is out of range	Check the squelch threshold setting or reduce the distance between transmitter and receiving antenna
RF signal available, no audio signal, "MUTE" display appears on the display panel	Transmitter is muted ("MUTE")	Deactivate the muting function
	Receiver's squelch threshold is adjusted too high	Reduce the squelch threshold
	Transmitter doesn't transmit a pilot tone	Activate the pilot tone transmission
Audio signal has a high level of background noise	Transmitter sensitivity is adjusted too low	See "Adjusting the sensitivity" on page 53
	Receiver's AF output level is adjusted too low	Increase the audio output level
Audio signal is distorted	Transmitter sensitivity is adjusted too high	See "Adjusting the sensitivity" on page 53
	Receiver's AF output level is adjusted too high	Reduce the AF output level

If problems occur that are not listed in the above table or if the problems cannot be solved with the proposed solutions, please contact your local Sennheiser agent for assistance.

Recommendations and tips

... for the SKM 500 G2 radiomicrophone

- Hold the SKM 500 G2 in the middle of the microphone body. Holding it close to the sound inlet basket will influence the microphone's pick-up pattern, holding it at the lower part of the body will reduce the transmitter's range.
- You can vary the bass reproduction by increasing/decreasing the talking distance.
- For best results, make sure that the transmitter sensitivity is correctly adjusted.

... for optimum reception

- Transmission range depends to a large extent on location and can vary from about 10 m to about 150 m. There should be a "free line of sight" between transmitting and receiving antennas.
- To avoid overmodulating the receiver, observe a minimum distance of 5 m between transmitting and receiving antennas.

... for multi-channel operation

- For multi-channel operation, you can only use the channels in a channel bank. Each of the channel banks "1" to "8" accommodates up to 20 factory-preset frequencies which are intermodulation-free. For alternative frequency combinations, please refer to the enclosed frequency table. The freely selectable frequencies can be selected via the "TUNE" menu and can be stored in the channel bank "U".
- When using several transmitters simultaneously, interference can be avoided by maintaining a minimum distance of 20 cm between two transmitters.

Care and maintenance

Use a slightly damp cloth to clean the radiomicrophone from time to time.

Note:

Do not use any cleansing agents or solvents.

To clean the radiomicrophone's sound inlet basket, proceed as follows:

- ▶ Unscrew the sound inlet basket (turn counterclockwise) and remove it.

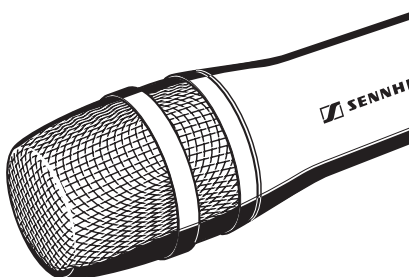

- ▶ Remove the foam insert.
- ▶ Use a slightly damp cloth to clean the sound inlet basket from the inside and outside.
- ▶ Reinsert the foam insert.
- ▶ Replace the sound inlet basket on the radiomicrophone and screw it tight (taking care not to loose the colored identification ring).

Specifications

RF characteristics

Modulation	wideband FM
Frequency ranges	518–554, 626–662, 740–776, 786–822, 830–866 MHz
Transmission frequencies	8 channel banks with up to 20 factory-preset channels each 1 channel bank with up to 20 freely selectable channels (1440 frequencies, tunable in steps of 25 kHz)
Switching bandwidth	36 MHz
Nominal/peak deviation	± 24 kHz / ± 48 kHz
Frequency stability	$\leq \pm 15$ ppm
RF output power at 50 Ω	typ. 30 mW

AF characteristics

Noise reduction system	Sennheiser HDX
AF frequency response	40–18,000 Hz
S/N ratio (at 1 mV and peak deviation)	≥ 110 dB(A)
THD (at nominal deviation and 1 kHz)	≤ 0.9 %

Overall unit

Temperature range	-10 °C to $+55$ °C
Power supply	2 AA size batteries, 1.5 V or BA 2015 accupack
Nominal voltage	2.4 V
Power consumption	
• at nominal voltage	≤ 170 mA
• with switched-off transmitter	≤ 250 μ A
Operating time	
• with batteries	≥ 8 h
• with BA 2015 accupack	≥ 8 h
Dimensions [mm]	$\varnothing 50$ x 225
Weight (incl. batteries)	approx. 450 g

Microphone heads

	MD 835	MD 845	ME 865
Transducer principle	dynamic	dynamic	condenser
Sensitivity	1.5 mV/Pa	1 mV/Pa	3 mV/Pa
Pick-up pattern	cardioid	super-cardioid	super-cardioid
Max. SPL	150 dB SPL	154 dB SPL	144 dB SPL
Color of identification ring	green	blue	red

Polar diagrams and frequency response curves of microphone heads

Polar diagram
MD 835

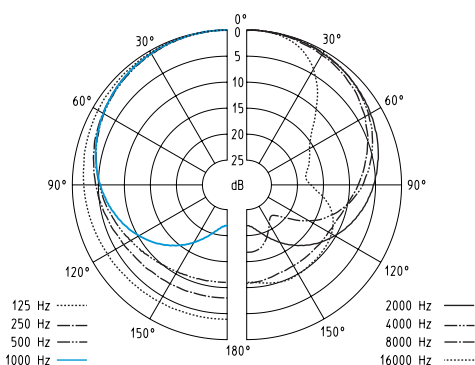

Polar diagram
MD 845

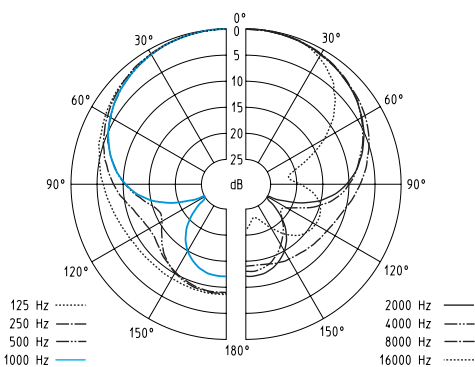

Polar diagram
ME 865

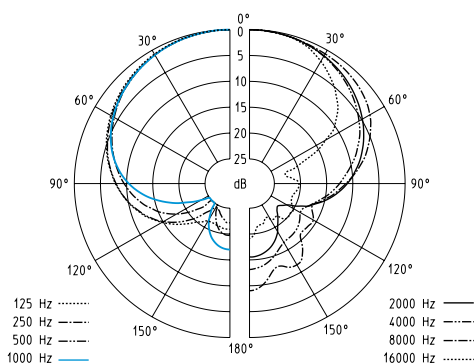

Frequency response curve MD 835

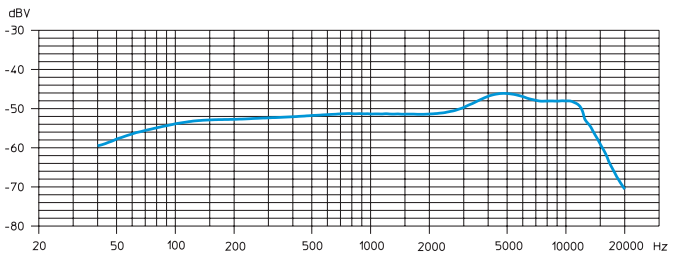

Frequency response curve MD 845

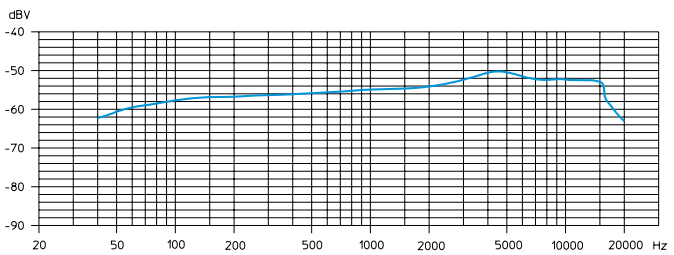

Frequency response curve ME 865

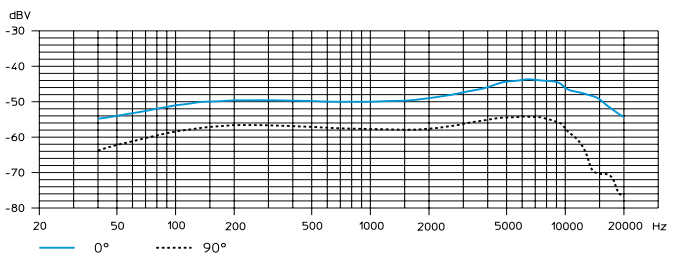

Accessories

- MD 835** Microphone head (green identification ring), dynamic, cardioid
- MD 845** Microphone head (blue identification ring), dynamic, super-cardioid
- ME 865** Microphone head (red identification ring), condenser, super-cardioid
- MMD 935** Microphone head (silver identification ring), dynamic, cardioid
- MZW 1** Wind- and popshield
- MZQ 1** Microphone clamp
- BA 2015** Accupack
- L 2015** Charger for BA 2015 accupack
- CC 2** Carrying case for ew 500 G2 system
- KEN** 8 color-coded identification caps for radiomicrophone

DEUTSCH

Wir übernehmen für das von Ihnen gekaufte Produkt eine Garantie von 24 Monaten. Ausgenommen hiervon sind dem Produkt beigelegte Zubehörartikel, Akkus und Batterien; denn diese Produkte haben wegen ihrer Beschaffenheit eine kürzere Lebensdauer, die zudem im Einzelfall konkret von Ihrer Nutzungsintensität abhängt.

Die Garantie-Zeit beginnt ab Kaufdatum. Zum Nachweis heben Sie bitte unbedingt den Kaufbeleg auf. Ohne diese Nachweise, die der zuständige Sennheiser-Service-Partner prüft, werden Reparaturen grundsätzlich kostenpflichtig ausgeführt.

Die Garantieleistungen bestehen nach unserer Wahl in der unentgeltlichen Beseitigung von Material- oder Herstellungsfehlern durch Reparatur, Tausch von Teilen oder des kompletten Geräts. Von der Garantie ausgenommen sind Mängel durch unsachgemäßen Gebrauch (z.B. Bedienungsfehler, mechanische Beschädigungen, falsche Betriebsspannung), Verschleiß, aufgrund höherer Gewalt und solche Mängel, die Ihnen beim Kauf bereits bekannt sind. Der Garantieanspruch erlischt bei Eingriffen in das Produkt durch nicht autorisierte Personen oder Werkstätten.

Im Garantiefall senden Sie das Gerät inklusive Zubehör und Kaufbeleg an den für Sie zuständigen Service-Partner. Zur Vermeidung von Transportschäden sollte möglichst die Original-Verpackung verwendet werden.

Ihre gesetzlichen Mängelansprüche aus dem Kaufvertrag gegen den Verkäufer werden durch diese Garantie nicht eingeschränkt. Die Garantie kann, außer in den USA, weltweit in allen Ländern in Anspruch genommen werden, in denen das jeweils nationale Recht unseren Garantiebestimmungen nicht entgegensteht.

ENGLISH

The guarantee period for this Sennheiser product is 24 months from the date of purchase. Excluded are accessory items, rechargeable or disposable batteries that are delivered with the product; due to their characteristics these products have a shorter service life that is principally dependent on the individual frequency of use.

The guarantee period starts from the date of original purchase. For this reason, we recommend that the sales receipt be retained as proof of purchase. Without this proof (which is checked by the responsible Sennheiser service partner) you will not be reimbursed for any repairs that are carried out.

Depending on our choice, guarantee service comprises, free of charge, the removal of material and manufacturing defects through repair or replacement of either individual parts or the entire device. Inappropriate usage (e.g. operating faults, mechanical damages, incorrect operating voltage), wear and tear, force majeure and defects which were known at the time of purchase are excluded from guarantee

claims. The guarantee is void if the product is manipulated by non-authorised persons or repair stations.

In the case of a claim under the terms of this guarantee, send the device, including accessories and sales receipt, to the responsible service partner. To minimise the risk of transport damage, we recommend that the original packaging is used. Your legal rights against the seller, resulting from the contract of sale, are not affected by this guarantee.

The guarantee can be claimed in all countries outside the U.S. provided that no national law limits our terms of guarantee.

FRANÇAIS

La période de garantie pour ce produit Sennheiser est de 24 mois à compter de la date d'achat. Sont exclues, les batteries rechargeables ou jetables livrées avec le produit. En raison de leurs caractéristiques ces produits ont une durée de vie plus courte liée principalement à la fréquence d'utilisation.

La période de garantie commence à la date de l'achat. Pour cette raison, nous vous recommandons de conserver votre facture comme preuve d'achat. Sans cette preuve – qui est vérifiée par Sennheiser – aucune prise en compte de la garantie ne pourra être retenue.

La garantie comprend, gratuitement, la remise en état de fonctionnement du matériel par la réparation ou le remplacement des pièces défectueuses ou dans le cas où la réparation n'est pas possible, par échange du matériel. L'utilisation inadéquate (mauvaise utilisation, dégâts mécaniques, tension électrique incorrecte), sont exclus de la garantie. La garantie est invalidée en cas d'intervention par des personnes non-autorisées ou des stations de réparation non agréées.

Pour faire jouer la garantie, retournez l'appareil et ses accessoires, accompagnés de la facture d'achat, à votre distributeur agréé. Pour éviter des dégâts durant le transport il est recommandé d'utiliser l'emballage d'origine.

Votre droit légal de recours contre le vendeur n'est pas limité par cette garantie. La garantie peut être revendiquée dans tous les pays à l'extérieur des Etats-Unis à condition qu'aucune loi nationale n'en invalide les termes.

ITALIANO

La Sennheiser garantisce il prodotto da voi acquistato per una durata di 24 mesi. Sono esclusi da questa garanzia gli accessori in dotazione con il prodotto, gli accumulatori e le batterie perché questi prodotti hanno un ciclo di vita più breve che dipende molto dall'intensità d'utilizzo. Il periodo di garanzia decorre dalla data dell'acquisto. Fa fede il documento d'acquisto valido agli effetti fiscali che deve essere

conservato. Senza questo documento, che deve essere controllato dal centro di servizio Sennheiser, qualsiasi riparazione viene effettuata solo dietro pagamento.

Le prestazioni gratuite di garanzia possono consistere nell'eliminazione del difetto di materiale o fabbricazione attraverso la riparazione, la sostituzione di parti o del completo apparecchio, secondo nostro insindacabile giudizio. Sono esclusi dalla garanzia i guasti derivanti da cattivo uso dell'apparecchio (p.e. mancata osservanza delle istruzioni all'uso, danneggiamenti meccanici, tensione d'alimentazione errata), dall'usura, da cause di forza maggiore o da malfunzionamenti già a vostra conoscenza al momento dell'acquisto. La garanzia decade inoltre in caso di manomissioni effettuate da persone o centri di manutenzione non autorizzate. In caso di un reclamo nel periodo di garanzia vogliate inviare l'apparecchio insieme agli accessori in dotazione e il documento d'acquisto al vostro centro servizio autorizzato.

Per evitare danni di trasporto consigliamo di utilizzare l'imballo originale. In caso di guasto questa garanzia non pregiudica i vostri diritti derivanti dal contratto d'acquisto verso il negoziante dove è stato acquistato il prodotto.

La garanzia è estesa a tutti i paesi del mondo, tranne agli Stati Uniti, e può essere applicata se la legislazione nazionale lo permette.

ESPAÑOL

El periodo de garantía para este producto es de 24 meses desde la fecha de compra. Quedan excluidos los accesorios adjuntos al producto, acumuladores y baterías dado que, debido a sus características, la vida útil de dichos productos es mucho más corta y, en determinados casos, depende concretamente de la intensidad de utilización. El periodo de garantía comienza a partir de la fecha de compra. Por eso le recomendamos que guarde el recibo como prueba de compra. Sin dicha prueba, que será verificada por el respectivo concesionario Sennheiser, cualquier reparación que sea necesaria será efectuada contra factura.

Según determine el fabricante, las prestaciones de garantía consistirán en la eliminación gratuita de defectos de materiales o fabricación, por medio de reparación, sustitución de piezas, o bien en la sustitución del aparato completo. La garantía no tendrá validez en caso de defectos ocasionados por un uso inadecuado (tales como manejo incorrecto daños mecánicos, tensión de servicio equivocada), desgaste, o bien efectos de fuerza mayor, y desperfectos ya detectados en el momento de adquirir el producto. La garantía carecerá de validez si el defecto se debe a modificaciones y reparaciones hechas en el producto por personas o talleres no autorizados.

En caso de reclamación sírvase remitir el aparato incluyendo los accesorios y la factura al concesionario Sennheiser encargado de su zona. A fin de evitar daños durante el transporte se aconseja emplear el envase original. Las pretensiones legales por defectos y emanadas del contrato

de compraventa frente al vendedor, no quedan limitadas por esta garantía.

La garantía esta disponible en todos los países a excepción de EE.UU., siempre que la legislación nacional aplicable no sea contraria a nuestras determinaciones de garantía.

NEDERLANDS

Wij hanteren voor onze producten een garantietermijn gedurende een periode van 24 maanden. Uitgezonderd hiervan zijn accessoires, accu's en batterijen die aan het product toegevoegd zijn; op grond van hun geaardheid beschikken deze producten over een kortere levensduur die van geval tot geval van hun gebruiksintensiteit afhangt.

De garantietermijn begint vanaf de aankoopdatum. Daarom dient u de originele aankoop-bon goed te bewaren. Zonder dit bewijs, dat door de Sennheiser servicepartner wordt gecontroleerd, worden reparaties in principe tegen kostenvergoeding uitgevoerd.

De garantievergoedingen bestaan naar onze keuze uit het kosteloze verhelpen van materiaal- of fabricagefouten op basis van vervanging (afzonderlijke onderdelen of het complete apparaat) danwel reparatie. De garantie vervalt bij verkeerd gebruik of onachtzaamheid

(bijv. bedieningsfouten, mechanische beschadigingen, onjuiste bedrijfsspanning), slijtage gevallen van force majeure of gebreken welke u reeds bij de aankoop heeft gekend. Het recht op garantie vervalt indien reparaties of wijzigingen zijn uitgevoerd door niet bevoegde personen of werkplaatsen. Indien u aanspraak maakt op garantie dient u het apparaat, inclusief accessoires en aankoopbon, franco aan de bevoegde servicepartner toe te zenden. Om beschadigingen gedurende het transport te voorkomen adviseren wij de originele verpakking te gebruiken.

Uw wettelijke garantieclaims tegenover de verkoper worden door deze garantie niet beperkt. De garantie kan wereldwijd in alle landen buiten de VS worden opgevorderd waarin de geldende nationale wetten niet in tegenstelling zijn met onze garantievoorwaarden.

Bemerkung:

Vor Inbetriebnahme sind die jeweiligen länderspezifischen Vorschriften zu beachten!

Important:

Before putting the device into operation, please observe the respective country-specific regulations!

Important:

Avant d'utiliser l'appareil, veuillez observer les dispositions légales en vigueur dans votre pays.

Nota:

Prima della messa in funzione seguite le prescrizioni vigenti nel paese nel quale viene utilizzato!

Observación:

!Anterior a la puesta en funcionamiento deberán observarse las correspondientes ordenanzas nacionales!

Opmerking:

Voor inbedrijfstelling dient u de afzonderlijke landspecifieke voorschriften in acht te nemen!



Sennheiser electronic GmbH & Co. KG
30900 Wedemark, Germany
Phone +49 (5130) 600 0
Fax +49 (5130) 600 300
www.sennheiser.com